

PMx Sequential samplers **Giano & Gemini**

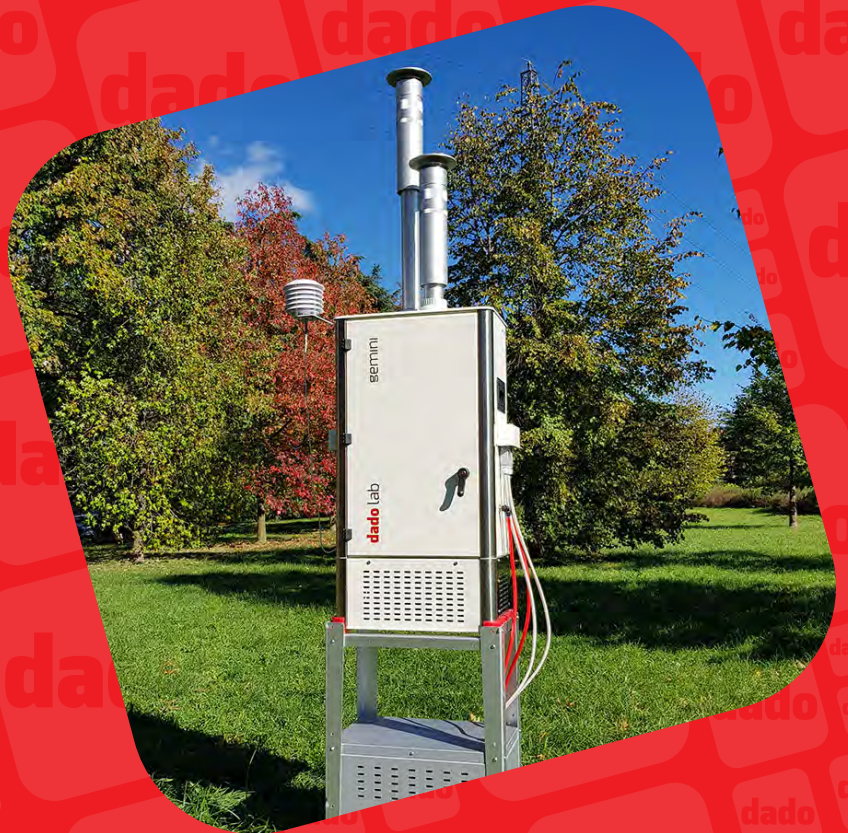



# PMx Sequential Samplers

## Description

The PMx sequential samplers Mod. Giano and Gemini were designed and realized by Dado lab to be more practical, easier to transport and with user friendly interface compared to other available solutions.

The common heart to both models is the multi-purpose core unit (MPC) which manages the sequential sampling on a single or double channels.

The MPC particular concept allows both outdoor cabinet solution or the 19" rack installation in shelters or mobile labs.



Particular attention was paid to the systems engineering with the target to reduce the number of the parts, which increases the reliability and reduces the size and weight infact, Giano and Gemini weight only 35 kgs without considering the pump/s and support stand

The MPC and the outdoor cabinet are designed to have forced internal air recirculation which helps to keep the ventilation tube, filter under sampling and exposed samples at ambient temperature.

The optional air conditioning unit, required for applications where ambient temperature values can be particularly high, keeps the filters area temperature below 25°C in case of ambient temperature exceeds 25°C.

The air conditioning unit is placed below the cabinet and offer the advantage to give high cooling performances. Despite other solutions, the air conditioning system doesn't require special protections or insulations for the filters tanks, which can still be easily accessed and changed on the field.

## Characteristics

In the single channel version Giano, the sampling pump is placed directly inside the cabinet while in the twin channel version "Gemini", the two pumps are placed in a separate module located on the bottom of the stand. The blank/exposed filters tank can load up to 21 filters to allow unattended operations up to three weeks.



The hardware platform of Giano and Gemini is based on the most recent industrial electronic standards which can grant high reliability and ruggedness.

The MPC features an advanced communication interface with different standards, from USB to Bluetooth.

Data communication is an aspect that Dado lab took in consideration, starting from USB key and arriving in the next future wireless data transfer to the new smart cartridge" supports, which will supply the highest data traceability level actually available on the market, and remote communication through mobile network.

The built-in sensors measures also ambient temperature, pressure and rH.

It's also available a weather station allowing to complete the data set also with wind speed and direction. All those data will be logged by the MPC and transferred with a comprehensive report.



## Display

Giano and Gemini are equipped with a high resolution color LCD display reporting the status, the ongoing operation and supplying the information "at the glance", including weather sensors information.

Most important information are concentrated on the main display, everything is logged.



## Program

Set up of the sampling schedule is much easier and faster thanks to the graphical interface and simplified software. Just set the number of channels (Gemini), starting time, daily cycle and it's done.

In case of power loss, data are safely secured and instrument will automatically resume on return of mains voltage



## Storage conditioning

After the sampling operation, exposed filters are stocked in a storage tank.

To fulfill the EN12341 request and avoid semi-volatile compounds loss, a high performances air conditioning system is available and automatically keeps the temperature of the storage tank below 23°C.

The air conditioning system is placed on the support stand, just below the instrument, and the cooling effect is enhanced by two fans pushing the air up in the filter storage area.

## Pneumatic circuit

The sample is taken from the inlet to the filter through a straight, insulated aluminum tube designed to minimize any kinetic, thermal, chemical or electrostatic effect which may lead to any PM loss.

The sampling flowrate is digitally controlled through an orifice meter with an accuracy better than 1%. This solution has proven to be highly reliable and allow the use of any type of pump.

The pump is the last element of the system. Along with a rationalized pneumatic system, this solution greatly increases the tightness of the sampling line while system management, maintenance costs and power consumption are reduced.

The sampling pump is a 4.5 m<sup>3</sup>/h and was chosen because of its characteristics :

- Performance: nominal flowrate up to 70 lt/min;
- Reliability: maintenance free for more than 12000 hours of operation;
- Ruggedness: the sampling pumps are treated with nitrocarburizing process which increase their resistance to oxydation and chemical aggression. Those pumps were tested on isokinetic sampling systems where proved to be highly reliable. operating under highly stressing conditions;

## Silent sampling pump

Quietness is a very important aspect for instruments usually located in urban areas, sometimes even on balconies, private gardens or schools.

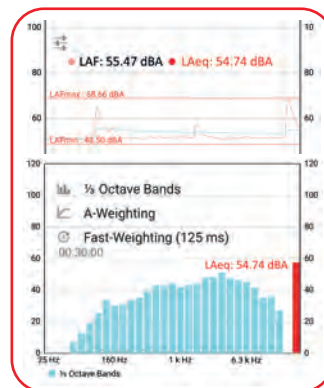

The pump chosen for the Giano/Gemini samplers are very quiet. Even if placed very close to housing areas or human activities, no disturb will be caused.



## Data management

Giano and Gemini have the most advanced communication technology available such as:

- USB Port
- Text Messaging for status/activation
- Data logging on smart cartridges
- Web based app for data transfer and remote control

Those options allow local/remote data transfer and also instrument control.

## USB Port

Allows to export data to an USB stick locally. Quick and easy way to transfer the data



## Text Messaging

The PMx samplers can be equipped with a GSM modem. This allows a basic remote control of the instrument which will respond to commands sent through text messages for sampling operation start and stop, alarm and status condition communication.

## Smart Cartridge

This is a unique feature of the Giano and Gemini developed by Dado lab to increase the traceability of the data. The instrument is supplied with special cartridges which can be programmed by the user before the sampling and by the unit during the operation.

Inside the filter cartridge there is a special memory chip which can be programmed with the most important information. Before the sampling, the user can enter information such as the filter initial weight and technician ID. During the sampling all the information about temperature and pressure conditions, volume, rH%, sampling time etc are stored permanently on the cartridge.



Sampling data are now linked with the filter and will always travel with it.

Once back to laboratory, the smart cartridges can easily and quickly transfer the data to the dedicated software using the our fast reading solution.

## Web based app (Cloud)

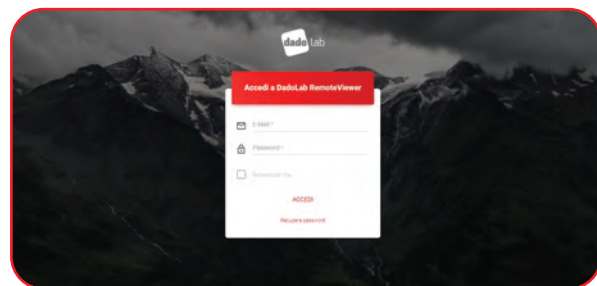

Dado lab PMx samplers are supplied with a network port granting the access and interface from the network.

This solution represent the cut edge technology available for data transfer or remote viewer and control.

Through internet, network or our modem\*, Giano and Gemini can be remotely accessed from our dedicated web platform where sampling reports, alarm status and history are available. it's also possible to program or modify the sampling schedule and conditions.

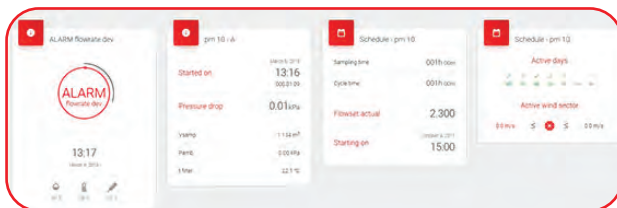
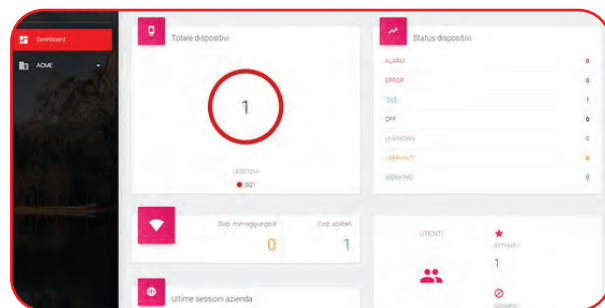

The access to web platform can be authorized through different level users.

Dado lab considers data safety and traceability as a priority, all those solutions combined will grant to our customers the safest way to always access to the sampling data.

\* For the web app remote connection, Dado lab supplies a M2M SIM card with 500 MB included. Customer can switch to more convenient data plan from Things Mobile website after registration.

in case the customer prefers to use its own SIM Data, this card must be enabled with "Public IP" option (denat). The modem will have to be reprogrammed in our service dept.

## Technical Characteristics

### General

Operation conditions	-20 ÷ 45°C
Stock conditions	-10 ÷ 50°C 95% UR
Max number of blank/exposed filters	21
Display	3.5" Graphic LCD (QVGA)
Data port	USB 2.0
Internal memory	16GB
Power supply	230 Vac ±10% 50/60Hz
Materials	Steel/Aluminum combined structure
Keyboard	Polycarbonate, tactile effect keys

### Weight

19" Rack Version Single Channel:	14 kg	19" Rack Twin Channel:	19 Kg
Outdoor Version (without head) Giano:	35 kg	Support stand:	5 Kg
Outdoor Version (without head) Gemini:	34 kg	Support stand (with two pumps):	25 Kg

### Power consumptions (230Vac 50Hz)

Giano (w/ Glass fibers filter)	0.65 A	approx 0.150 kW
Gemini (Both channels with GF filters)	1.30 A	approx 0.300 kW

### Integrated measuring sensors

#### Flowrate

Type	orifice meter
Range	10 ÷ 60 l/min
Resolution	0.01 l/min
Accuracy	± 1%

#### Ambient Pressure & Pressure Drop

Range	10 ÷ 105 kPa (1050 mBar)
Hysteresis and Linearity	0.25 % F.S
Resolution	0.01 kPa (0.1 mBar)
Accuracy	Better than 1% (± 0.25kPa)

#### Temperatures

Ambient	PT100
Range	-20 ÷ 100°C
Resolution	0.01°C
Uncertainty	≤ 1°C

#### Filter sampling/Storage

TC Type J	
Range	-20 ÷ 100°C
Resolution	0.01°C
Uncertainty	≤ 1°C

### Weather sensors

#### Relative Humidity %

Range	0 ÷ 100 %
Accuracy	± 5 % (range 0% to 60% RH)

#### Wind Speed

Range	0.5 ÷ 80 m/s
Resolution	0.1 m/s
Accuracy	± 1 m/s

#### Wind Direction

Resolution	8 sectors on compass rose
Accuracy	± 4°

### Dimensions

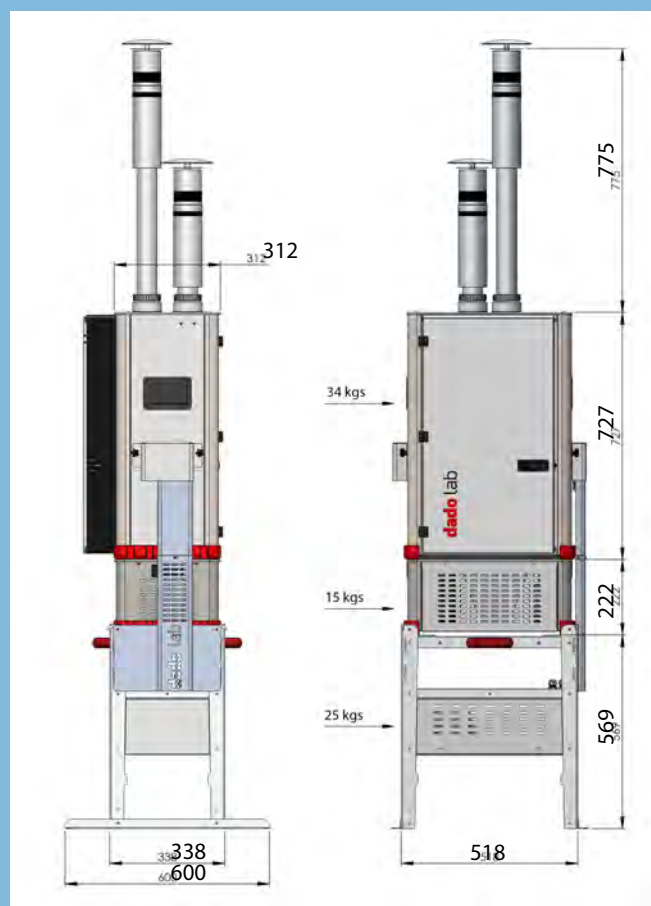

## Models, accessories and spare parts



- 102 101 1001 **Giano PMx Sequential Sampler (Outdoor version)**
- 102 101 1002 **Gemini PMx Sequential Sampler (Outdoor version)**
- 102 101 1011 **Giano PMx Sequential Sampler (19" Rack version)**
- 102 101 1012 **Gemini PMx Sequential Sampler (19" Rack version)**

Standard supply:

- Test and Calibration report
- Administration USB key
- Power cable
- User Manual



### 102 101 2001 **EN-LVS Sampling head**

EN-LVS PMx Sampling Head (PM10+PM2.5) operating at 2.3 m<sup>3</sup>/h including both PM10 and PM2.5 accelerating nozzles.

### 102 101 2010 **TSP-LVS Samplig head**

Sampling inlet for total suspended particles.

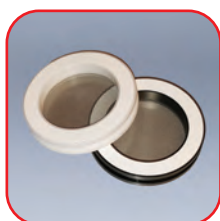

### 102 101 2050 **Box of 21 Smart Cartridges - White**

### 102 101 2051 **Box of 21 Smart Cartridges - Black**

POM cartridges for Ø 47mm filter membranes.

### 102 101 2080 **Giano Support Stand**

Realized in light aluminium, the stand is designed to support the single channel sequential sampler and the optional air-conditioning system for the twin channel.

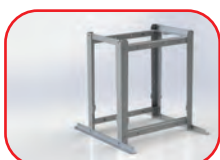

### 102 101 2070 **Air-conditioning System**

A proper air conditioning realized for the Gemini, where both sampled filters tanks need to be kept at controlled conditions to avoid loss of semi-volatile compounds, as required by EN12341.



### 102 101 2075 **Peltier Conditioning System**

Light and efficient liquid cooled Peltier expressly realized for single channel Giano. It keeps the sampled filters tank at controlled conditions to avoid loss of to avoid loss of semi-volatile compounds, as required by EN12341.

### 102 101 2100 **Wind Speed/Direction Sensor Interface**

Interface required for wind speed-direction / rain sensor

### 102 101 2101 **Wind Speed/Direction Sensor**

Weather station for wind speed-direction measurement



### 102 101 2093 **Modem UMTS per controllo remoto tramite portale Dado Lab**

includes 1 year free access to our web portal and SIM M2M with 500 MB of traffic

### 300 104 1111 **CF1 - Digital flow calibrator with 0,4-45 NL/min range and rH probe**

Primary calibrator for flowrate, volume, temperature and relative humidity.

All parameters can be ISO17025 certified. Includes adapter for e a Giano/Gemini/1PMx